



# COPARTNET

COPARTNET.COM ELECTRONIC LTD.

## 利優電子公司簡介

[WWW.COPARTNET.COM](http://WWW.COPARTNET.COM)

[WWW.5GHOME.COM](http://WWW.5GHOME.COM) (on line shop)



No.264, Wenhua Rd., Yingge Dist.,  
New Taipei City 239, Taiwan (R.O.C.)  
TEL:886-2-2679-5800  
FAX:886-2-8677-5624  
MAIL:sales@copartnet.com





# COPARTNET

利優電子 COPARTNET.COM ELECTRONICs LTD.

我們的服務與特點

## 產品設計 & 整合 -

- 電子線與轉接模具與製據的設計, 包括與PCBA周邊配件相關的整合

## 協助電子零件/替代品的搜尋 -

- 同級/替代品的建議
- 同級/替代品的搜尋
- 協助客戶同時向多家材料廠商競價並確保出貨品質

## 合作效益-

- 從報價到出貨週期無延滯
- 協助客戶控管成本/避免影響成本的呆滯流程
- 從各地替代方案篩選出最佳的選擇
- 客製的測試流程, 包含防錯預防與偵錯機制.

## 網路商店 - ([www.5ghome.com](http://www.5ghome.com))

- 與倉庫庫存連貫同步顯示
- A small amount of supply can be combined for bulk shipment 少量採購可以與大貨整合出貨
- 簡易註冊, 只要您的email 與自訂密碼就可以馬上購物及詢價

## 包裝 -

- 協助將您的品牌, 您要的包裝, 呈現在您的產品上.





# COPARTNET

利優電子 COPARTNET.COM ELECTRONICS LTD.

## 服務內容範圍的細節

1. 客製品整合- 我們協助客戶進行模具開發、測試、採購組件、電路設計, 機構設計、QA 規範、申請認證、生產、包裝和運輸。
2. 模具資源配置- 單一工廠不可能擁有所有組裝規格所需的模具，否則需要高的毛利率來對外報價。 我司可協助整合各廠的模具來源, 盡可能為客戶節省模具開發成本。
3. 替代產品採購計劃（採購電子產品）- 通過採購系統和數以千計的零部件供應商的緊密聯繫，我司可幫助客戶找到高質量的替代零部件，以節省成本並滿足交貨時間。
4. 報價採購便捷 - 上千種產品可供參考選擇，小批量採購（[5ghome.com](http://5ghome.com)），大批量報價（[copartnet.com](http://copartnet.com)），客製品更有專屬鏈接電子表格 可提高全面高效的報價。
5. 上千種庫存商品可供選擇 - 靈活的最小起訂量，自營電商網站[www.5ghome.com](http://www.5ghome.com)，提供各種新舊線材、適配器、電子等產品類型，我司可提供多款大小批量的整合出貨機制。





# COPARTNET

利優電子COPARTNET.COM ELECTRONICs LTD.

## 服務內容範圍的細節

- 22年的累積, 我們的客製電子線的製程能力已經涵蓋到以下領域：線束、通訊、面板線纜、電腦線纜（IDC/Flat/FFC Cable）、顯示器D-SUB線纜、按鈕開關/DC線纜、USB-C、A/V、RF、充電器、適配器和任何弱/DC 電源線加工或模具開發 w/pcba 焊接或壓接類型。我們盡力提供標準電纜，定制電纜，為產品集成（協助競價）和質量控制服務尋找最佳替代部件。如果我們的 OEM 成本低於您目前提供的成本，這確實是一個值得考慮的解決方案。
- 電纜/電子線等通用標準規格的詢價，請加入會員（僅輸入您的郵箱和自訂密碼）即可開啟查詢功能；關於客製品需求的查詢，請參考以下定制產品需求查詢網站（[www.copartnet.com](http://www.copartnet.com)）  ...其格式化的電子表格可以讓客戶更有效的溝通並了解定詢價過程中所有可能的環節。
- 此外，對我司詢價等同與2000多位廠商的間接連結. 我們的採購數據庫系統與中台地的各種電子/替代品製造商有著密切的連結，絕對是為您提供解決方案的最佳解決問題夥伴。該機制還及時供應客戶對其它電子材料的需求。除了幫助客戶節省材料成本外，歡迎與其他不同產品的小批量出貨（我們的在線商店，[www.5ghome.com](http://www.5ghome.com)）和電纜/適配器等散裝貨物整合到一起發貨。



利優電子有限公司  
www.5ghome.com  
www.copartnet.com

產品管理	廠商系統管理	庫存作業	庫存查詢	庫存統計	5GHOME管理	COPARTNET管理	系統管理
CRM管理	客戶管理	JB系統	CHARLES專區	IFD 定流庫	new5GHOME管理		帳號管理

功能列表	廠商系統管理	庫存作業	庫存查詢	庫存統計	5GHOME管理	COPARTNET管理	系統管理	CRM管理	客戶管理	JB系統	CHARLES專區	IFD定流庫	new5GHOME管理
產品管理	產品	庫存	歷史	統計	會員列表	會員列表	帳號						







# COPARTNET

利優電子COPARTNET.COM ELECTRONIC LTD.

我們的辦公室, 倉庫及相關工廠





# COPARTNET

利優電子 COPARTNET.COM ELECTRONIC LTD.

## 相關認證







# COPARTNET

利優電子COPARTNET.COM ELECTRONIC LTD.

產品製程的領域分類

◎PCBA Integration

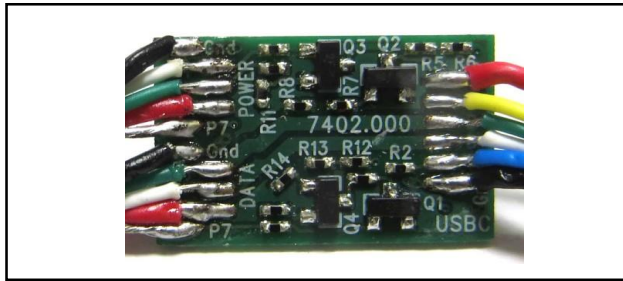

◎Wire & Cable Design

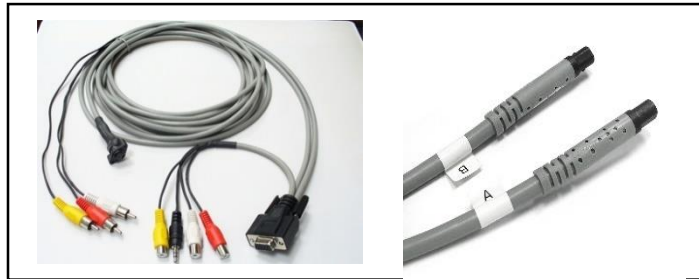

◎Adapter

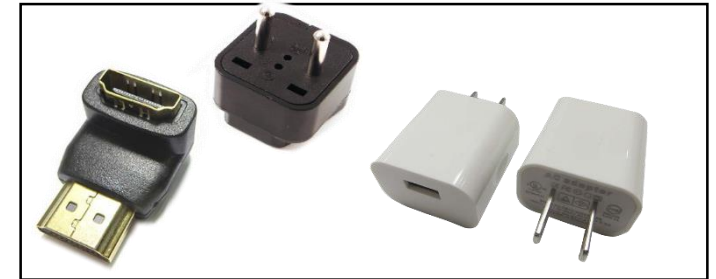

◎Customized Cable Assembly Electronics



◎Developing Mold Tooling



◎Sourcing Alternative

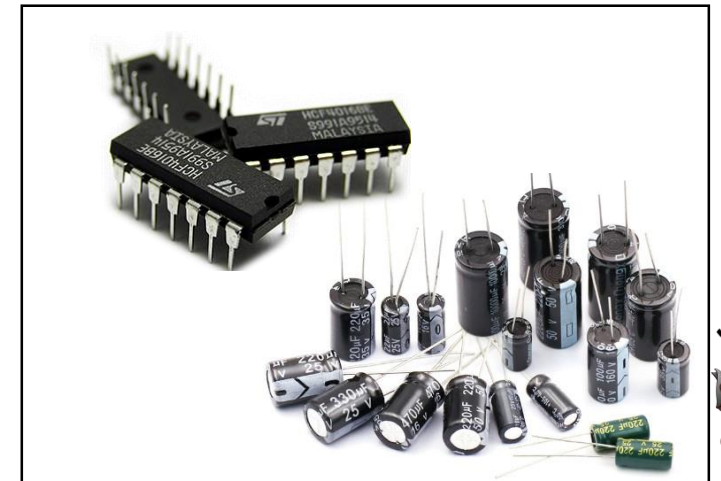







# COPARTNET

利優電子COPARTNET.COM ELECTRONIC LTD.

產品線

- Type-C & USB series

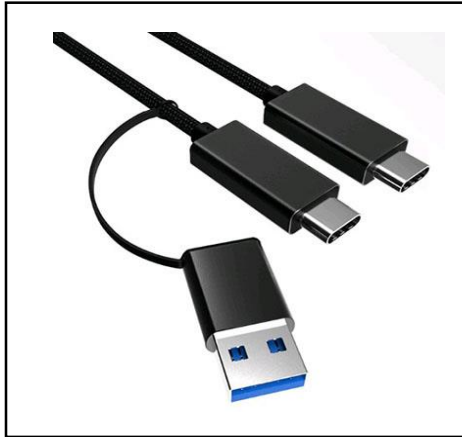



# COPARTNET

利優電子COPARTNET.COM ELECTRONIC LTD.

客製產品整合

## • PCBA/Mold Development Integration







# COPARTNET

利優電子 COPARTNET.COM ELECTRONIC LTD.

電子零件相關

## • Electronics/Alternative Parts







# COPARTNET

利優電子 COPARTNET.COM ELECTRONIC LTD.

車用相關配線

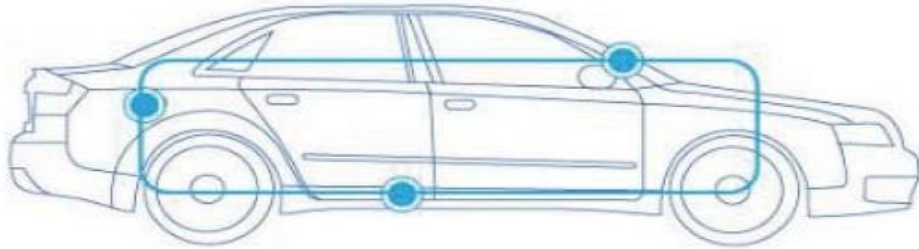

Car AV/Control cable



Air condition cable



Headlights cable



FAKRA cable



HSD cable



AV cable



Starter cable



HDMI cable



Camera cable



AVM cable



Solenoid Valve cable  
(for Shift Lever)





# COPARTNET

利優電子 COPARTNET.COM ELECTRONIC LTD.

工業控制相關線纜

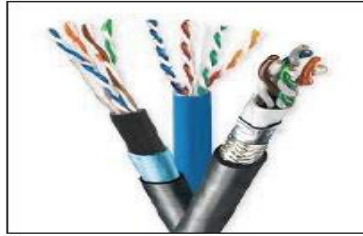

## Product Category

- Multi-core cables
- Multipair cable
- Drag chain cable

## Application

- Signal transmission
- Communication systems
- Instrument control
- Adapter
- Repeater

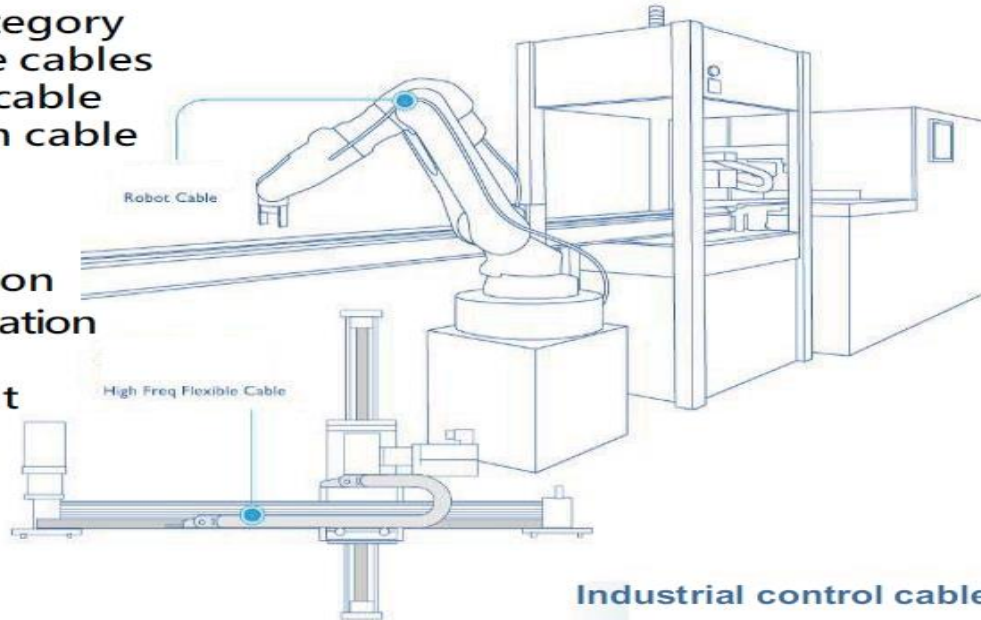





# COPARTNET

利優電子 COPARTNET.COM ELECTRONIC LTD.

專業領域的用線

## Medical Cable Patient Observational Equipment Cable



ECG/ EKG cable



EEG cable



Defibrillation cable



TEMP cable



EMG cable



SpO2 cable



NIBP cable



IBP cable

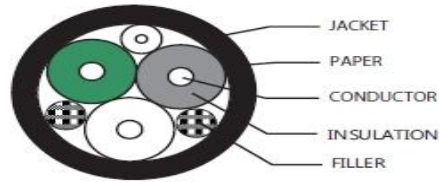

## Electric Car Cable

Style	Hard Usage		Extra Hard Usage	
	EVJE	EVJT	EVE	EVT
Temperature	90, 105	60, 75, 90, 105	90, 105	60, 75, 90, 105
Voltage, V	300		600	
Conductor Size mm <sup>2</sup> (AWG)	0.824 – 3.31 (18 – 12AWG)		0.824 – 253 (18 AWG – 500 kcmil)	
Core	2 – 6		2 or more	
Insulation	TPE	PVC	TPE	PVC
Jacket	TPE	PVC	TPE	PVC



## NMEA2000 Vessel signal cable

- Rated temperature : 80°C
- Rated Voltage : 30 volts
- Conductor : 24AWG~18AWG
- Insulation : 発泡PE / PVC
- Shielded : Aluminum and braided
- Jacket : PVC (Grey or Blue)
- Construction : 1P+1P+AB
- Issu : NMEA 2000®

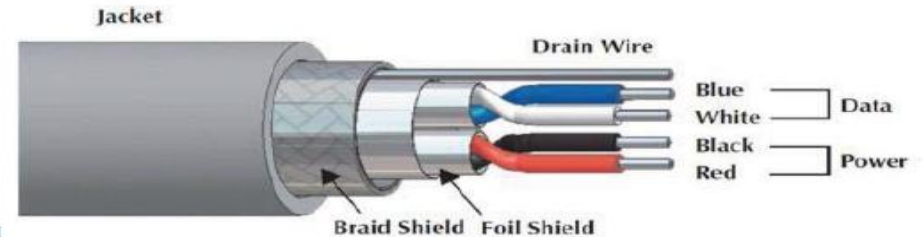





# COPARTNET

利優電子 COPARTNET.COM ELECTRONIC LTD.

其它客製開模品, 金屬連結器及轉接器





# COPARTNET

利優電子 COPARTNET.COM ELECTRONIC LTD.

辦公室, 倉庫位置圖

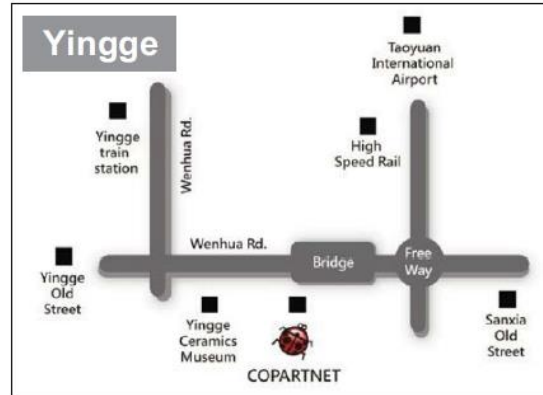
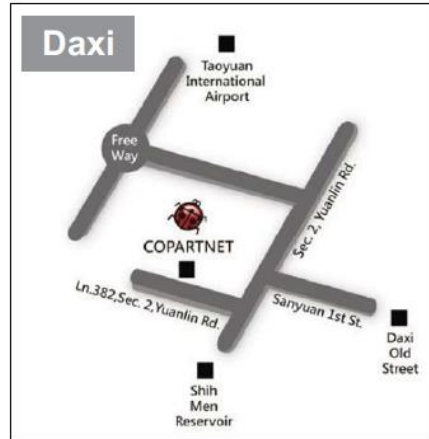

No.264, Wenhua Rd., Yingge Dist.,  
New Taipei City 239, Taiwan (R.O.C.)

TEL:886-2-2679-5800  
FAX:886-2-8677-5624

MAIL:sales@copartnet.com

