



# COPARTNET

COPARTNET.COM ELECTRONIC LTD.

## Company Profile

[WWW.COPARTNET.COM](http://WWW.COPARTNET.COM)

[WWW.5GHOME.COM](http://WWW.5GHOME.COM) (on line shop)



No.264, Wenhua Rd., Yingge Dist.,  
New Taipei City 239, Taiwan (R.O.C.)  
TEL:886-2-2679-5800  
FAX:886-2-8677-5624  
MAIL:sales@copartnet.com





# COPARTNET

COPARTNET.COM ELECTRONICs LTD.

## *Our Service Features*

### **Design & integration -**

- Tooling and assembly fixture design, includes related PCBA and integration with peripherals

### **Sourcing -**

- Equivalent substitution recommendations and Sourcing
- Compare the best quality and price from various material suppliers
- Procurement server - Inquiring about us is equivalent to inquiring about dozens of factories through our purchasing system.

### **Value-Added -**

- Quick turn-around time from quotation to production delivery.
- Cost Reduction/Cost Avoidance through process and product improvements.
- Assist customers in comparison and select screening to find the best fitted alternatives
- Making an inquiry to us is equivalent to making an inquiry to dozens of factories through our procurement system at the same time

### **Online Store - ([www.5ghome.com](http://www.5ghome.com))**

- Synchronized with our warehouse.
- A small amount of supply can be combined for bulk shipment
- Easy access, Just register your email and self-set password to start inquiry or shopping

### **Package -**

- Your logo, your packaging, on your products





# COPARTNET

COPARTNET.COM ELECTRONICS LTD.

## *Scope of Our Competency/Service*

1. Custom product integration - We assist customers in mold development, testing, sourcing components, design modifications, QA specifications, certification, production, packaging, and shipping.
2. Mold resource allocation - It is impossible for a single factory to have the molds required for all assembly specifications, otherwise a high gross profit rate is required to quote externally. We assist in integrating mold production from various factories, and as much as possible save customers on mold development costs.
3. Alternative product sourcing plans (sourcing electronics) – Through procurement systems and links with thousands of component vendors, we help customers find high-quality alternative parts to save costs and meet delivery times.
4. Convenient quotation procurement - Thousands of products are available for reference selection, with small-scale purchases (5ghome.com), large-scale quotations (copartnet.com), as well as custom products having a dedicated link e-form for more comprehensive and efficient quotations.
5. Thousands of inventory items available for selection - Flexible MOQ, self-operated e-commerce website, www.5ghome.com, offers a variety of new and old cables, adapters, electronics, and other product types, with the quantity only increasing. We welcome cross-border integration (small & large scale orders) for bulk shipments.





# COPARTNET

COPARTNET.COM ELECTRONICS LTD.

## Scope of Competency/Service Details

- Our custom cable capabilities have crossed over to the following fields: wire harness, communication, panel cables, computer cable (IDC/Flat/FFC Cable), display D-SUB cables, button switch/DC cable, USB-C, A/V, RF, chargers, adapters, and any weak/DC power cables processing or mold development w/ pcba in soldering or crimping type. We try our best to provide standard cables, customized cables, searching the best alternative parts for product-integration (assistance bidding) and QC service. If our OEM cost is lower than your current supplied, this is indeed a solution worth considering.
- For general standard specifications such as cable/electronics inquiries, please join the membership (input your email and password only) to start the inquiry function; For inquiries about customized product requirements, Please refer to the following website for inquiries about customized product requirements (on [www.copartnet.com](http://www.copartnet.com)  Custom Made and Product Sourcing )...its formatted e-form allows customers to better understand all possible requirements during the customized specification inquiry process.
- In addition, our procurement database system, with strong connections with various electronics/alternatives manufacturers all over Taiwan and China, is definitely the best problem-solving partner to provide you with custom cable solutions. The mechanism also timely supplies the customer's needs for other electronic materials. In addition to helping customers save material costs, it can also be integrated into one shipment with other small-volume shipments of different products (our on-line shop, [www.5ghome.com](http://www.5ghome.com)) and bulk goods of cable/adaptor, etc.



利優電子有限公司  
www.5ghome.com  
www.copartnet.com

產品管理	廠商系統管理	庫存作業	庫存查詢	庫存統計	5GHOME管理	COPARTNET管理	系統管理
CRM管理	客戶管理	JB系統	CHARLES專區	IFD 定流庫	new5GHOME管理		帳號管理

**功能列表**

產品管理	廠商系統管理	庫存作業	庫存查詢	庫存統計	5GHOME管理	COPARTNET管理	系統管理	CRM管理	客戶管理	JB系統	CHARLES專區	IFD定流庫	new5GHOME管理
產品	廠商	庫存	庫存	統計	會員列表	會員列表	帳號						





# COPARTNET

COPARTNET.COM ELECTRONIC LTD.

*Our Office, Inventory and Factory*





# COPARTNET

COPARTNET.COM ELECTRONIC LTD.

*Our Certificates*



**D&B D-U-N-S® Registered™ Certificate**  
 鄧白氏企業認證證書

鄧白氏企業認證證書 (D&B D-U-N-S® Registered™ Certificate) is a global standard for business credibility. It is issued by Dun & Bradstreet, a leading provider of business information and credit services. The certificate is valid for 12 months and is recognized by over 100 million businesses worldwide.

鄧白氏企業認證證書 (D&B D-U-N-S® Registered™ Certificate) is a global standard for business credibility. It is issued by Dun & Bradstreet, a leading provider of business information and credit services. The certificate is valid for 12 months and is recognized by over 100 million businesses worldwide.

**經濟部標準檢驗局**  
 BUREAU OF STANDARDS, METROLOGY AND INSPECTION  
 中華民國標準檢驗局

經濟部標準檢驗局 (Bureau of Standards, Metrology and Inspection) is a government agency responsible for the development and implementation of standards and metrology in Taiwan. The certificate is issued by the Bureau of Standards, Metrology and Inspection (BSMI) and is valid for 12 months.





# COPARTNET

COPARTNET.COM ELECTRONIC LTD.

*Our Product Process Fields*

◎PCBA Integration

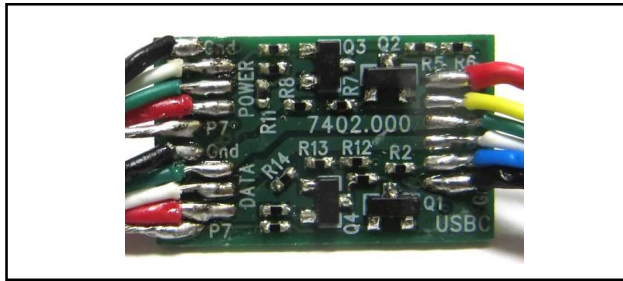

◎Wire & Cable Design

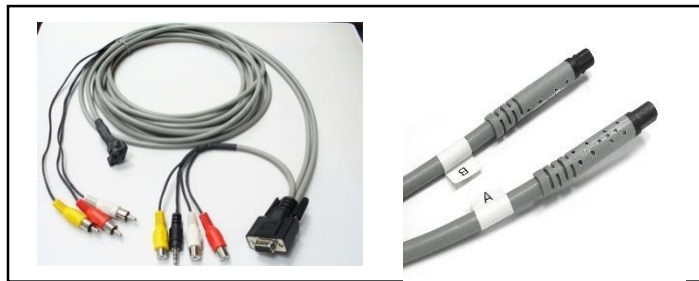

◎Adapter



◎Customized Cable Assembly Electronics



◎Developing Mold Tooling



◎Sourcing Alternative

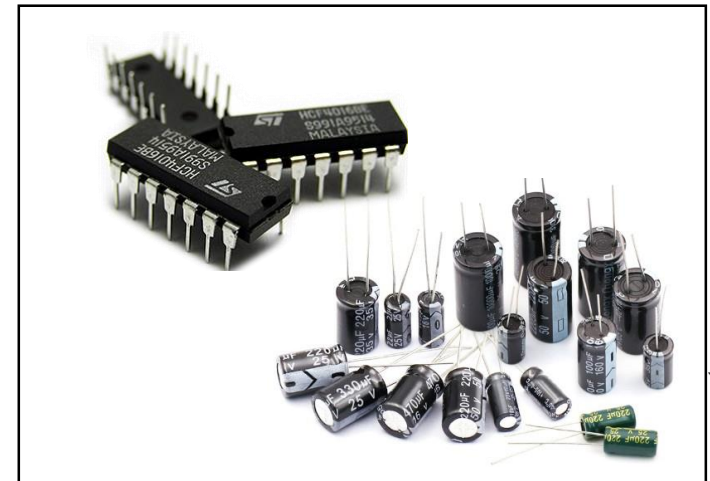



# COPARTNET

COPARTNET.COM ELECTRONIC LTD.

*Our Product Lines*

- Type-C & USB series

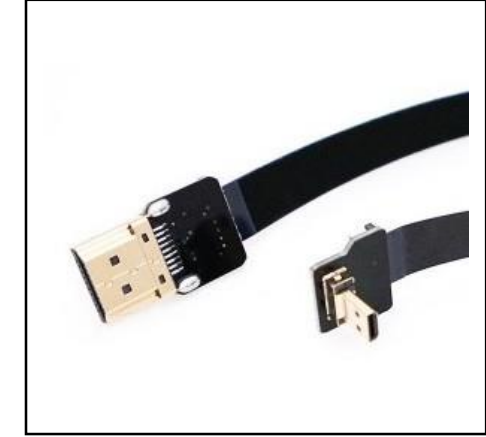
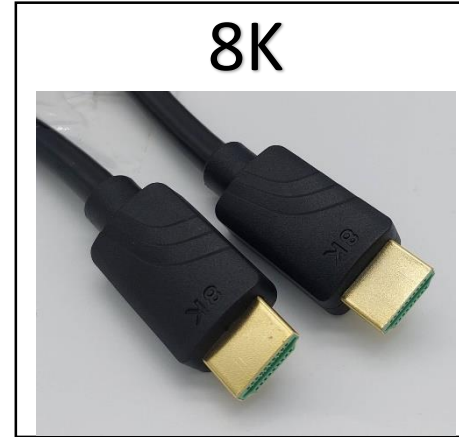





# COPARTNET

COPARTNET.COM ELECTRONIC LTD.

*Our product lines*

- PCBA/Mold Development Integration





# COPARTNET

COPARTNET.COM ELECTRONIC LTD.

*Our Product Lines*

- Electronics/Alternative parts





# COPARTNET

COPARTNET.COM ELECTRONIC LTD.

## *Car Related Cables*

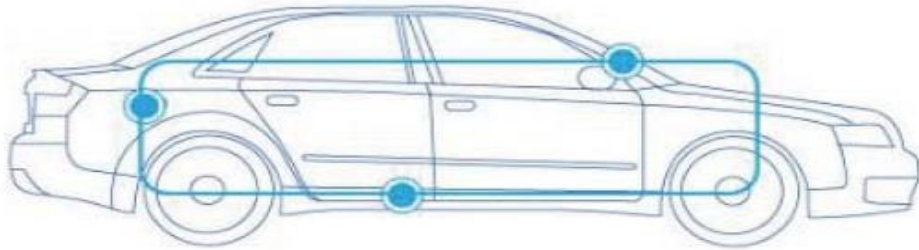

Car AV/Control cable



Air condition cable



Headlights cable



FAKRA cable



HSD cable



AV cable



Starter cable



HDMI cable



Camera cable



AVM cable



Solenoid Valve cable  
(for Shift Lever)





# COPARTNET

COPARTNET.COM ELECTRONIC LTD.

## Industrial Control Cables



- Product Category**
- Multi-core cables
  - Multipair cable
  - Drag chain cable

- Application**
- Signal transmission
  - Communication systems
  - Instrument control
  - Adapter
  - Repeater

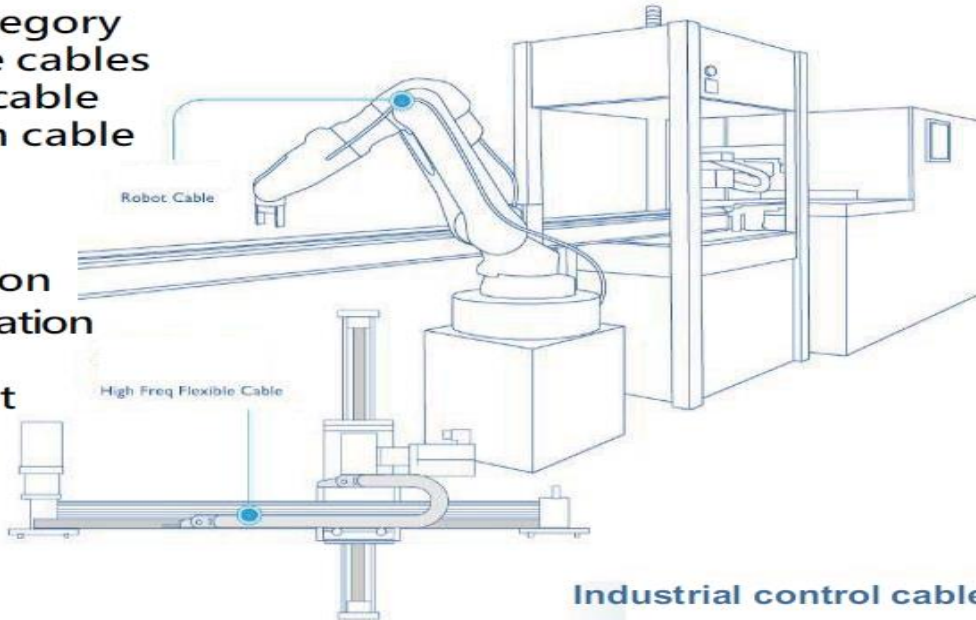

Industrial control cable





# COPARTNET

COPARTNET.COM ELECTRONIC LTD.

*Cables in Professional Fields*

## Medical Cable Patient Observational Equipment Cable



ECG/ EKG cable



EEG cable



Defibrillation cable



TEMP cable



EMG cable



SpO2 cable



NIBP cable



IBP cable

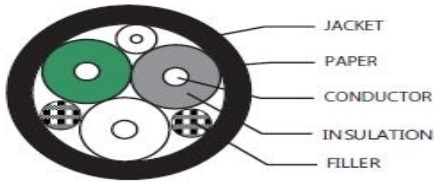

## Electric Car Cable

Style	Hard Usage		Extra Hard Usage	
	EVJE	EVJT	EVE	EVT
Temperature	90, 105	60, 75, 90, 105	90, 105	60, 75, 90, 105
Voltage, V	300		600	
Conductor Size mm <sup>2</sup> (AWG)	0.824 – 3.31 (18 – 12AWG)		0.824 – 253 (18 AWG – 500 kcmil)	
Core	2 – 6		2 or more	
Insulation	TPE	PVC	TPE	PVC
Jacket	TPE	PVC	TPE	PVC

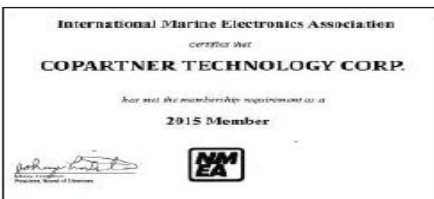

## NMEA2000 Vessel signal cable

- Rated temperature : 80°C
- Rated Voltage : 30 volts
- Conductor : 24AWG~18AWG
- Insulation : 発泡PE / PVC
- Shielded : Aluminum and braided
- Jacket : PVC (Grey or Blue)
- Construction : 1P+1P+AB
- Issu : NMEA 2000®

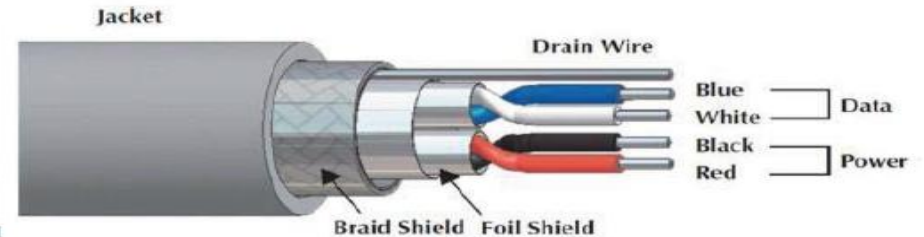



# COPARTNET

COPARTNET.COM ELECTRONIC LTD.

*Other Custom Molded Cables,  
metal connector and Adapters*





# COPARTNET

COPARTNET.COM ELECTRONIC LTD.

*Office/Inventory Locations*

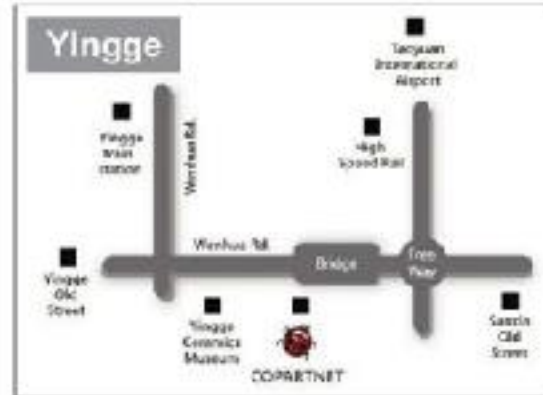
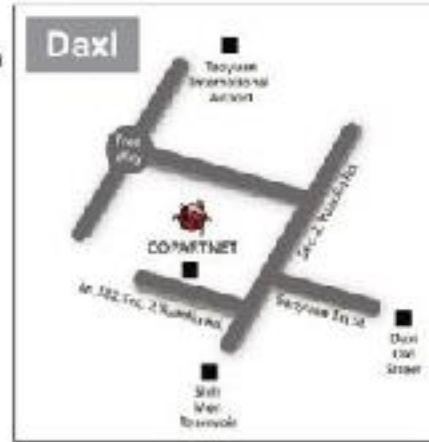

No.264, Wenhua Rd., Yingge Dist.,  
 New Taipei City 239, Taiwan (R.O.C.)

TEL:886-2-2679-5800  
 FAX:886-2-8677-5624  
 MAIL:sales@copartnet.com

